

Safety Precautions

INKJET PRINTER

TS330-3200 DS

Safety Precautions

You can also download the latest manual from official website.

MIMAKI ENGINEERING CO., LTD.

<https://mimaki.com/>

D203849-10
Original instructions

TABLE OF CONTENTS

Introduction	3
To Ensure Safe Use	5
Symbol Marks	5
Usage Precautions	6
Notes on Handling Ink or any Other Liquid Used with the Machine	10
Restrictions Concerning the Expiration Date of Ink Used in the Machine	11
Installation Precautions.....	12
Installation Space	13
When Relocating This Machine	13
Safety Interlocks	14
Warning Label.....	15

Other Precautions

Introduction

Thank you for purchasing the Inkjet printer TS330-3200DS.

Read the safety precautions ("this document" hereinafter) thoroughly and make sure you understand its contents to ensure safe and correct use of the product.

Please note that the illustrations contained in this manual are intended to show functions, procedures, or operations and may sometimes differ slightly from the actual machine.

Unauthorized reproduction of any portion of this document is strictly prohibited.

© 2024 MIMAKI ENGINEERING Co., Ltd.

● DISCLAIMERS

- MIMAKI ENGINEERING REJECTS ALL LIABILITY FOR DAMAGE ARISING DIRECTLY OR INDIRECTLY FROM THE USE OF THE TS330-3200DS ("THIS MACHINE" HEREINAFTER), WHETHER OR NOT THE PRODUCT IS FAULTY.
- MIMAKI ENGINEERING REJECTS ALL LIABILITY FOR DAMAGE, DIRECT OR INDIRECT, TO MATERIALS CREATED WHILE USING THIS MACHINE.
- USING THIS MACHINE IN CONJUNCTION WITH DEVICES OTHER THAN THOSE RECOMMENDED BY MIMAKI ENGINEERING MAY RESULT IN FIRE OR ACCIDENTS. SUCH INCIDENTS ARE NOT COVERED BY THE PRODUCT WARRANTY. MIMAKI ENGINEERING REJECTS ALL LIABILITY FOR DAMAGE, DIRECT OR INDIRECT, ARISING FROM SUCH INCIDENTS.
- USE ONLY GENUINE MIMAKI ENGINEERING INK AND MAINTENANCE LIQUID. USE OF OTHER PRODUCTS MAY RESULT IN FAILURES OR REDUCE PRINT QUALITY. SUCH INCIDENTS ARE NOT COVERED BY THE PRODUCT WARRANTY. MIMAKI ENGINEERING REJECTS ALL LIABILITY FOR DAMAGE, DIRECT OR INDIRECT, ARISING FROM SUCH INCIDENTS.
- DO NOT ATTEMPT TO REFILL THE INK PACKS WITH UNAUTHORIZED INK. SUCH INCIDENTS ARE NOT COVERED BY THE PRODUCT WARRANTY. MIMAKI ENGINEERING REJECTS ALL LIABILITY FOR DAMAGE, DIRECT OR INDIRECT, ARISING FROM SUCH INCIDENTS.

● TV and radio interference



- The machine emits high-frequency electromagnetic radiation while operating. Under certain circumstances, this may result in TV or radio interference. We make no guarantee that this machine will not affect special radio or TV equipment.
-

If radio or TV interference occurs, check the radio or TV reception after turning off the machine. If the interference disappears when the power is turned off, the machine is likely to be the cause of the interference.

Try any of the following solutions or combinations of these solutions:

- Change the orientation of the TV or radio antenna to find a position where interference does not occur.
- Move the TV or radio away from this machine.

● Voluntary restraint of electromagnetic interference

This product is VCCI Class A information technology equipment. Use of this product at home may cause jamming. Such incidents may require the user to take appropriate measures. VCCI-A

● FCC (Federal Communications Commission) regulations

The machine has been tested and certified to comply with restrictions applying to Class A digital devices under Part 15 of the FCC regulations. These restrictions are designed to provide suitable protection from harmful interference when the printer is used in commercial environments.

This product may generate, use, or emit radio frequency energy and may cause harmful interference with radio communications if not installed or used in accordance with the operating manual.

Use of this product in residential areas may cause harmful interference. If so, the user is responsible for rectifying such interference.











- Use only the cables recommended by Mimaki Engineering when connecting to the machine. Use of other cables may cause the product to exceed the restrictions stipulated by FCC regulations. To maintain compliance with FCC regulations, use the cables recommended by Mimaki Engineering.
-

To Ensure Safe Use

Symbol Marks

This document uses symbol marks to explain precautions when operating the machine. Make sure you fully understand the meaning of each mark to ensure safe and correct use of the machine.

Explanation		
	Warning	Indicates a potential hazard that may result in death or serious injury if handled improperly or if instructions are disregarded.
	Caution	Indicates a potential hazard that may result in minor or moderate injury if handled improperly or if instructions are disregarded.
	Notice	Indicates a potential hazard that may result in property damage if handled improperly or if instructions are disregarded.
	Warning sign	Indicates something that requires attention. Warning specifics are drawn inside the symbol.
	Mandatory action sign	Indicates an action that must be carried out. The specifics of the mandatory action are drawn inside the symbol.
	Prohibition sign	Indicates a prohibited action. The specifics of the prohibited action are drawn inside the symbol.
	Important	Indicates important information related to use of this machine.
	Tip	Indicates useful reference information.
	Reference information	Indicates the corresponding page for related information.

Usage Precautions

● In the event of abnormal conditions

WARNING



- In the event of abnormal conditions such as smoke or unusual odor, turn off the main power immediately and turn off the breaker. Continuing to use the machine under these conditions may result in failure, electric shock, or fire. Once you have confirmed that smoke is no longer being emitted, contact your local dealer or our service office. Never attempt to repair the machine yourself, which is hazardous.

CAUTION



- Immediately wipe off any ink, maintenance liquid, waste ink, or other liquid used with the product that comes into contact with your skin. Then wash using soap, and rinse with plenty of water. Failure to wash off ink may result in skin inflammation. If your skin becomes irritated or painful, seek medical attention immediately.
- If ink, maintenance liquid, waste ink, or any other liquid used in the product comes into contact with your eyes, rinse immediately with plenty of clean water. Rinse for at least 15 minutes. If you wear contact lenses and they can be easily removed, remove after rinsing for at least 15 minutes with clean water. Be sure to also rinse the undersides of your eyelids. Failure to rinse off ink may result in blindness or impaired vision. If your eyes become irritated or painful, seek medical attention immediately.
- If ink, maintenance liquid, waste ink, or any other liquid used in the product enters your mouth or is swallowed, gargle with water immediately. Do not induce vomiting. Seek medical attention promptly. Inducing vomiting may cause liquid to enter the airway.
- If a large amount of vapor is inhaled, move to a well-ventilated area, keep warm, and rest in a posture that allows easy breathing. If the condition does not improve, seek medical attention promptly.
- Then contact the emergency number written on the SDS.

NOTICE



- If an ink leak occurs, turn off the main power immediately and turn off the breaker. Then, contact your local dealer or our service office.

● Power supply precautions

⚠ WARNING



- Do not damage or modify the power cable. Do not place heavy objects on, heat or stretch it. Doing so may damage the cable, leading to electric shock or fire.
- Do not use the power cable if it is damaged or broken or if the core wire is exposed. Otherwise there is a risk of failure, electric shock, or fire.



- Always connect the machine to a switchboard with grounded polarity. Otherwise there is a risk of failure, electric shock, or fire. All electrical work (Class C grounding work; formerly Type 3 grounding work) must be handled by a licensed electrician.

NOTICE



- Do not turn off the main power supply. Turning off the main power supply will disable the automatic maintenance function (including nozzle clogging prevention function and ink discharge channel cleaning function). This increases the risk of ejection failures (such as nozzle clogging or deflection).

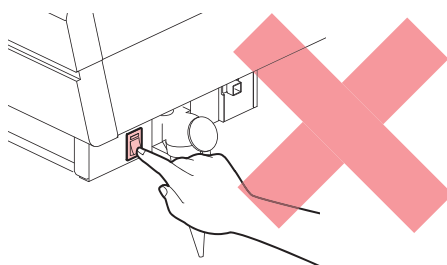

- Use the machine with a power supply that meets specifications.
- When connecting the power cable, check the input voltage of the power outlet and the capacity of the breaker. Also, connect each cable to a separate power source with an independent breaker. Connecting to power outlets linked with the same breaker will cause the breaker to trip.

● **Caution regarding moving parts**

 **CAUTION**



- Keep parts of the body such as the face and hands away from moving parts. Also keep clothing (e.g., loose clothing and accessories) that may impede work away from the machine. Failure to do so may result in injury.



- Long hair should be tied back. Failure to do so may result in injury.

● **Do not disassemble or repair**

 **WARNING**



- Do not attempt to disassemble or repair this machine. Otherwise there is a risk of failure, electric shock, or fire.

● **Heater**

 **CAUTION**



- The heater becomes extremely hot. Do not touch with bare hands.

NOTICE



- Condensation may form on the print head nozzle surface depending on the ambient temperature and humidity. The formation of condensation may cause ejection failures (e.g., nozzle clogging or deflection). Perform head cleaning if any ejection failures (e.g., nozzle clogging or deflection) occur during printing.
Set the platen heater to a temperature not exceeding 35 °C, and ensure that the ambient temperature is within the permissible operating temperature range (20 to 30 °C).  ["Installation Precautions"\(P. 12\)](#)

● **Other usage precautions**

 **WARNING**



- Keep children away from the machine.

NOTICE



- Do not pull the media when the clamp lever is lowered (the media is clamped). Doing so may damage the machine.



- The underside of the media may be soiled depending on how the printed media has been stored (due to weight when laying printed media rolls horizontally, for example) and the media type. Perform a test beforehand to check that the media does not transfer ink to the underside of the adjacent media.

● **Disposing of the product**

 **CAUTION**



- Please contact your local retailer or service agent.
 - When disposing of the product yourself, contact an industrial waste disposal operator or dispose of the product in accordance with local laws and regulations.
-

Notes on Handling Ink or any Other Liquid Used with the Machine

Precautions regarding ink, maintenance liquid, or other liquids used with this machine are included with the containers. Thoroughly read them and make sure you understand the contents.



- Be sure to read the safety data sheet (SDS) before use. <https://mimaki.com/supply/sds/>

CAUTION



- Pay close attention to ventilation and be sure to wear safety glasses, gloves, and a mask when handling ink, maintenance liquid, waste ink, or other solutions used with the machine. Leaking ink may adhere to the skin or get into the eyes or mouth.



- Do not subject cases containing ink to strong shock or violent shaking. Do not attempt to refill the ink. Leaking ink may adhere to the skin or get into your eyes or mouth.



- Do not disassemble cases containing ink. Leaking ink may adhere to the skin or get into your eyes or mouth.



- Do not store ink, maintenance liquid, or other liquids used with the machine in locations where children may enter.



- When disposing of ink, maintenance liquid or other liquid used with the product, or containers or non-woven fabric contaminated with ink or other liquid, contact an industrial waste disposal operator or dispose of the product in accordance with the local laws and regulations.

NOTICE



- Do not store ink, maintenance liquid, or other liquids used with the machine in locations exposed to direct sunlight.
- Do not store ink, maintenance liquid, or other liquids used with the machine in environments where cutting fluid or other volatile substances (such as amines or modified amine alcohol) are present in significant quantities. Storage in such places increases the risk of failure or ejection failures (e.g., nozzle clogging or deflection).
- Do not use ink, maintenance liquid, or other liquids used with this machine with other printers. Doing so may cause failure.



- Be sure to store them in a low place no higher than 1 m above the floor. Otherwise there is a risk of scattering if the containers fall.
- Store in tightly sealed containers.
- Store in a cool, dark place.
 - (1) Store ink in a place where ink does not freeze. Using defrosted ink may deteriorate ink constituents and reduce print quality.
 - (2) When ink is moved from a cold place to a warm place, leave it in the environment where the machine is installed for at least three hours before using it.
 - (3) Open the container just before installing it, and use it up as quickly as possible. If it is opened and left for an extended period of time, print quality may be reduced.



- Do not touch the metal parts of the ink IC chip. Static electricity may damage the ink IC chip, and dirt or damage may cause the ink IC chip read error.



- Printing is disabled if a different ink IC chip is used.
-

Restrictions Concerning the Expiration Date of Ink Used in the Machine

Example: When the expiration date is April 20xx

- May 20xx: Replace with new ink or use up as quickly as possible. Printing is possible.
- June 20xx: Replace with new ink or use up as quickly as possible. Printing is possible.
- July 20xx: Printing is not possible.



- The message appears on the display.



- The ink expiration date is indicated on the ink container. Expired ink may cause ejection failures or alter the color tone. Printing is possible even if the ink has passed its expiration date. Nevertheless, we recommend replacing with new ink or using up as quickly as possible.
-

Installation Precautions

⚠ WARNING



- Do not install the machine in a place close to fire.
- Do not place flower vases, pots, cups, containers containing cosmetics, chemicals or water, or small metal items on or close to the machine. If they enter the machine, there is a risk of failure, electric shock, or fire.



- Do not install this machine in humid locations or locations where it may be exposed to splashing water. Otherwise there is a risk of failure, electric shock, or fire.



- Do not install the machine in a place where children may enter.

⚠ CAUTION



- A ventilation system must be provided if this machine is installed in a poorly ventilated area or sealed room.
- Be sure to observe the following points when installing an extractor outlet:
 - (1) The extractor outlet must be installed in accordance with applicable local EHS (environmental, health, and safety) guidelines.
 - (2) If the extractor outlet is fitted with a shutoff valve, the valve must be open when this machine is in use.



- Two mist exhaust units are provided on the top face of the machine. For the exhaust equipment to be connected to the exhaust ducts, please check the exhaust duct specifications provided with the machine below and make the necessary preparations by the customer.
 - (1) Inner diameter: $\phi 100$ mm
 - (2) Length: 1 m (maximum 3 m when extended)

NOTICE



- Do not install this machine in locations where dust or powder is present. Failure or printing defects may result (e.g., nozzle clogging, deflection) if dust gets inside this machine.
- Do not install this machine in locations exposed to drafts (e.g., from air conditioning). Disregarding this precaution may result in dust or powder getting inside this machine.
- Do not install this machine in unstable locations or locations subject to vibration. This will increase the risk of failure or printing defects (e.g., nozzle clogging, deflection).
- Do not install this machine in locations exposed to direct sunlight.
- Do not install this machine in locations subject to sudden temperature changes. This will increase the risk of failure or printing defects (e.g., nozzle clogging, deflection).
- Do not install this machine in locations exposed to excessive noise from large machinery.
- Do not install this machine in locations where photographic fixing agents generate vapor or acid gas (e.g., acetic acid, hydrochloric acid) or locations filled with metal working fluids or highly volatile substances (e.g., amines, amine-modified alcohols). Malfunctions or printing defects may result (e.g., nozzle clogging, deflection) as print head ink is more likely to harden under such environments.



- Operating environment: 20 to 30 °C (68 to 86 °F), 35 to 65 %RH (no condensation)
- Temperature range in which accuracy is guaranteed: 20 to 25 °C (68 to 77 °F)

Installation Space

Provide the following space around the machine to allow safe and proper replacement of ink and media:

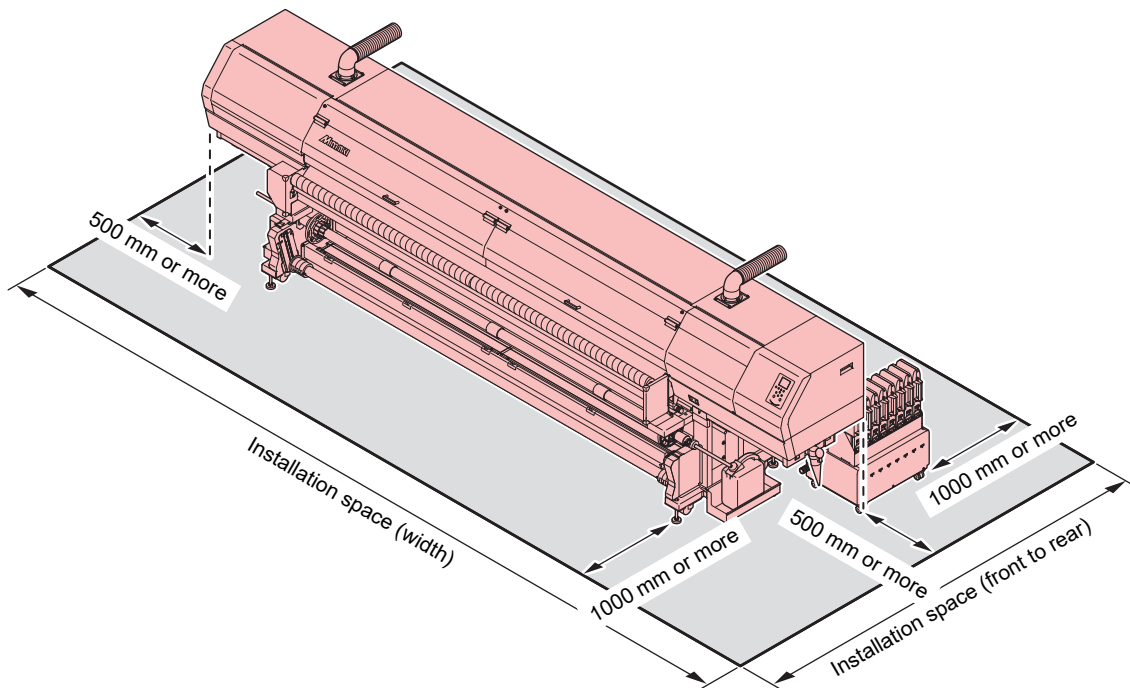

● TS330-3200DS

Size	TS330-3200DS
Width ^{*1}	At least 6,500 mm (5,410 mm)
Depth ^{*1}	At least 3,100 mm (1,075 mm)
Height ^{*1}	(1,650 mm)
Weight	Main unit: 925 kg, external supply unit: 43 kg

*1. The figures in parentheses indicate machine dimensions.

When Relocating This Machine

Contact your local dealer or our service office. Attempting to handle relocation yourself may result in failure or damage.

Safety Interlocks

The machine is equipped with interlocks to ensure safety during use.

Printing will abort if you open the covers while printing is underway. The RIP data will need to be resent.

- Safety interlock locations

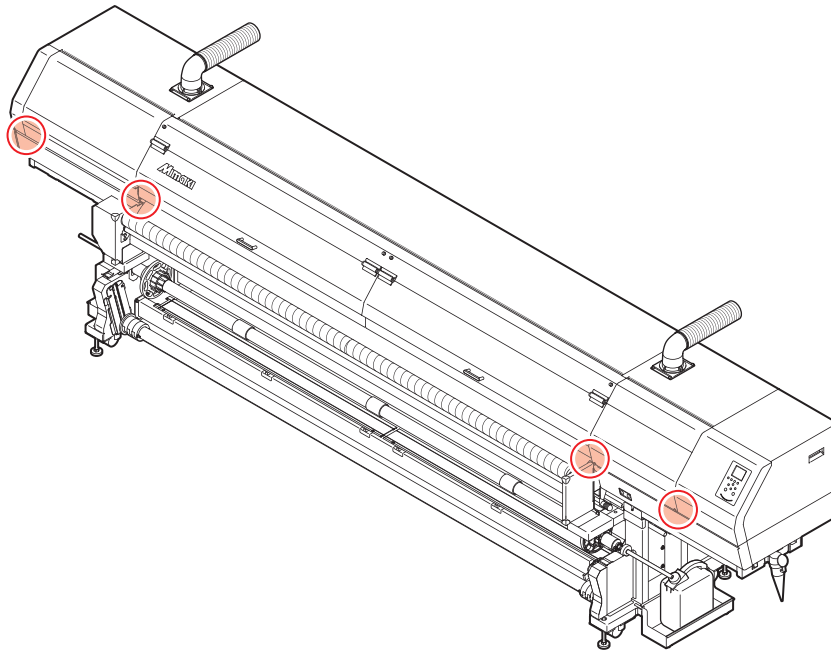







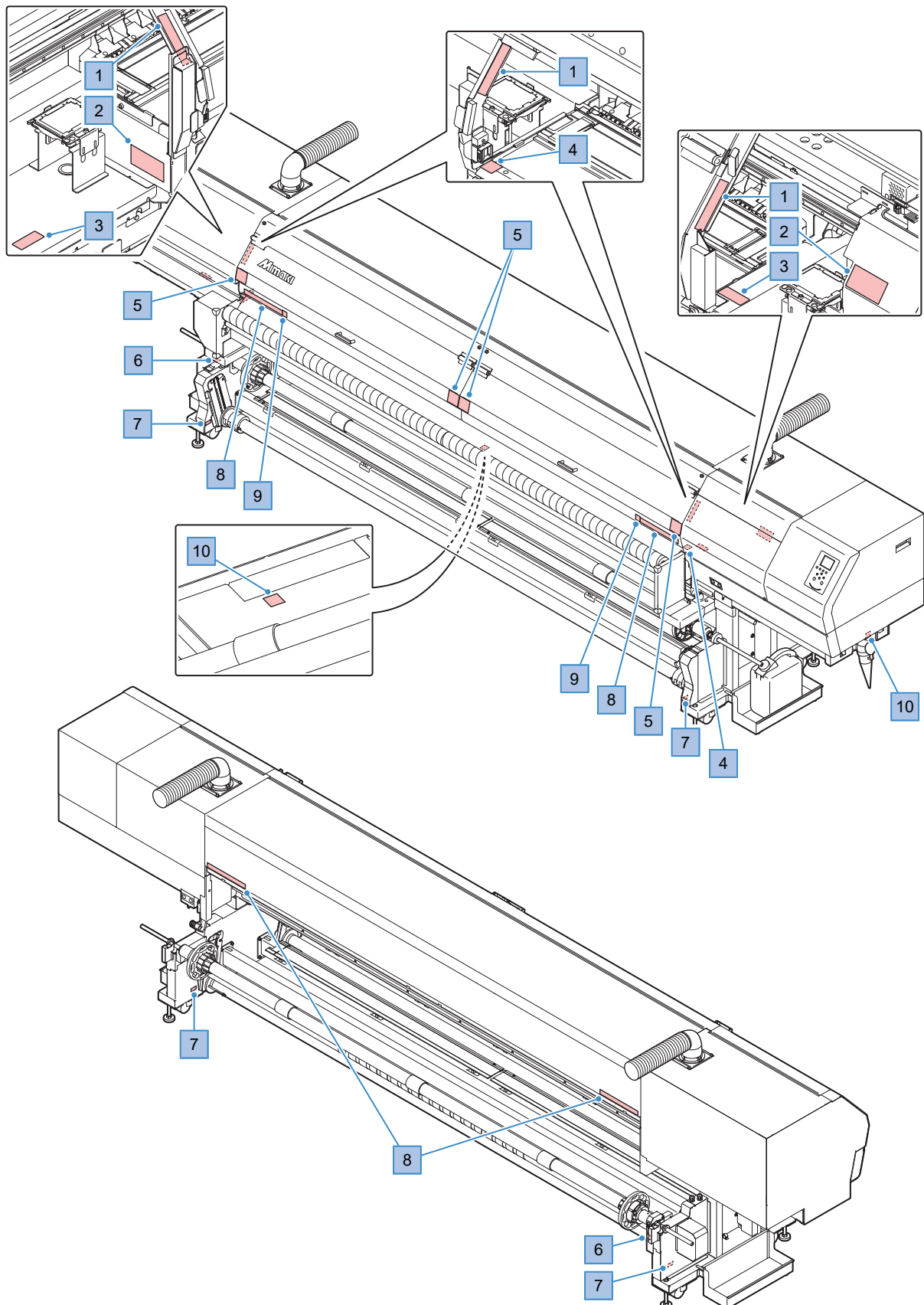



Warning Label

Make sure you fully understand the details indicated on the various warning labels.

If any of the warning labels becomes dirty and illegible or peel off, contact your local dealer or our service office to request new warning labels.



No.	Order code	Label	Details
1	M912523		Indicates dangerous moving parts.
2	M912522		Indicates dangerous moving parts.
3	M903330		Wear safety glasses and gloves while working.
4	M903239		Indicates hot parts.
5	M910931		Beware of opening and closing parts. Injury may result if hands become trapped.
6	M905811		Indicates dangerous moving parts. (Cut from the No. 8 label.)
7	M912054		Indicates dangerous moving parts.
8	M905811		Indicates dangerous moving parts.
9	M907833		Indicates dangerous moving parts.
10	M907935		Indicates dangerous live parts.

Other Precautions

This chapter lists specifications and functions of this machine.

Safety precautions

Nov, 2024

MIMAKI ENGINEERING CO.,LTD.

2182-3 Shigeno-otsu, Tomi-shi, Nagano 389-0512 JAPAN

D203849-10-12112024

